

**BROEN-LAB
UNIFLEX™
FITTINGS FOR
NON-BURNING
4.0 GASES /
OXYGEN**

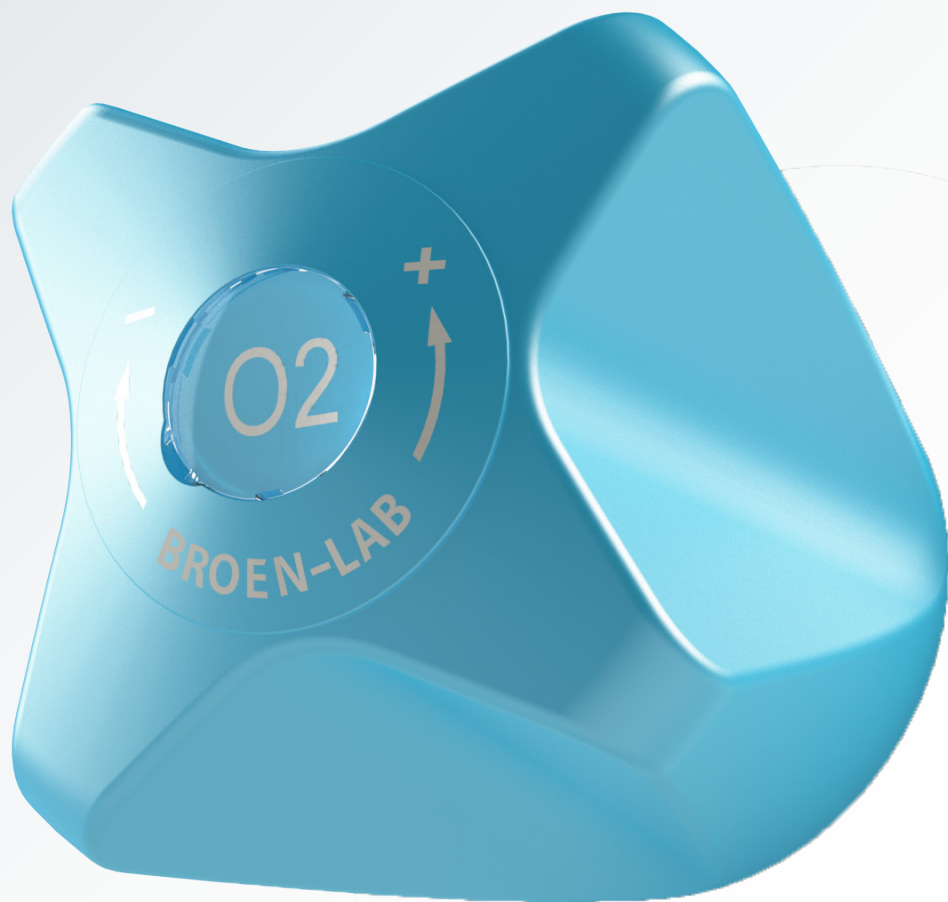







BROEN-LAB UNIFLEX™ FITTINGS FOR NON-BURNING 4.0 GASES / OXYGEN

BROEN-LAB UNIFLEX™ FITTINGS FOR NON-BURNING 4.0 GASES / OXYGEN

Polypropylene handle

BROEN-LAB

TABLE OF CONTENTS

Content	Page
Table of Content	2
Product Overview	3
BROEN-LAB UniFlex™	4-5
Fittings for Non-burnig 4.0 Gases/Oxygen	
Turret Fittings	 6-7
Suspended Fittings with 90° Valves	 8-9
Suspended Fittings with 45° Valves	 10-11
Double Wall Fittings with 90° Valves	 12
Double Wall Fittings with straight Valves	 13
Wall Mounted Fittings with 90° Valves for Exposed Piping	 14
Suspended or Wall Mounted Fittings	 15
BROEN-LAB UniFlex™ Hoses for Non-burning 4.0 Gases/Oxygen	15
Headworks	
Needle Headwork	16
Micro Flow Headwork	16
Accessories / Spare Parts	17
Ordering Information	
BROEN-LAB UniFlex™ Fittings.....	18

PRODUCT OVERVIEW

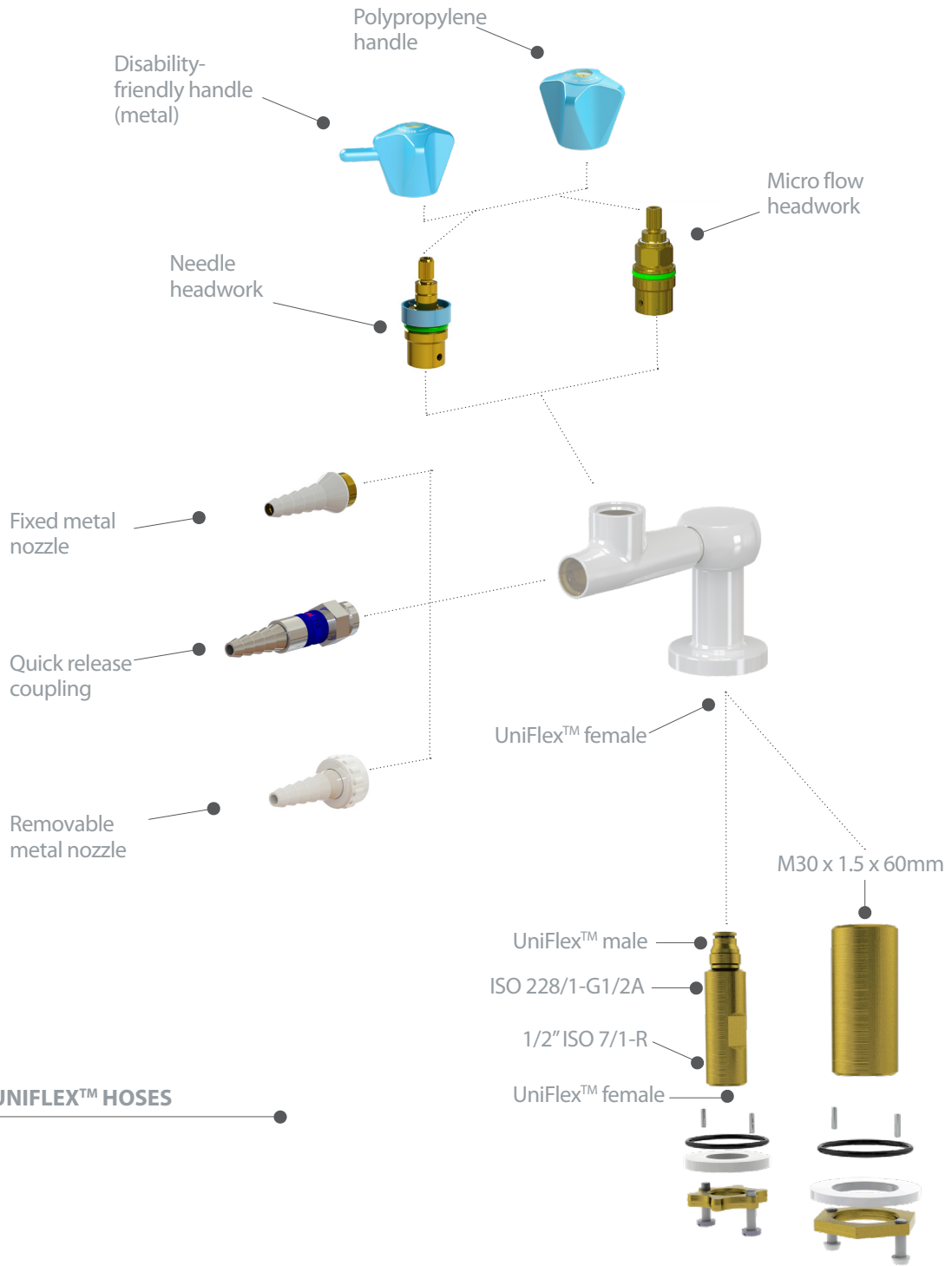

BROEN-LAB UNIFLEX™ HOSES

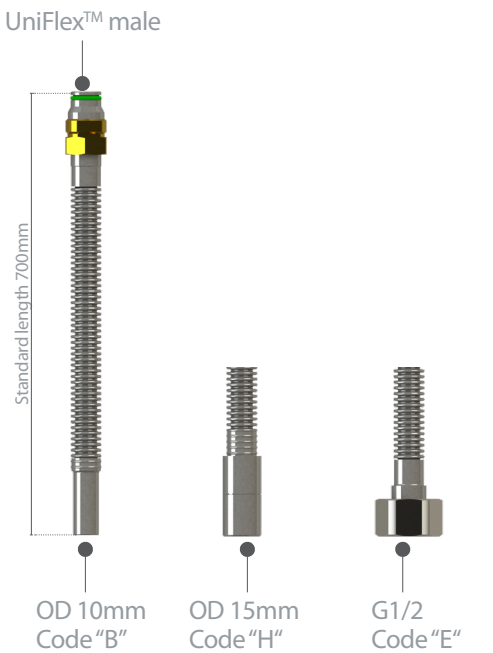

BROEN-LAB UNIFLEX™ FITTINGS FOR NON-BURNING 4.0 GASES / OXYGEN

THIS IS BROEN-LAB UNIFLEX™

BROEN-LAB UniFlex™ line offers a very high quality and durability combined with the complete program, which adds up to low LCC (Life Cycle Costs).

BROEN-LAB UNIFLEX™ FITTINGS FOR NON-BURNING 4.0 GASES / OXYGEN

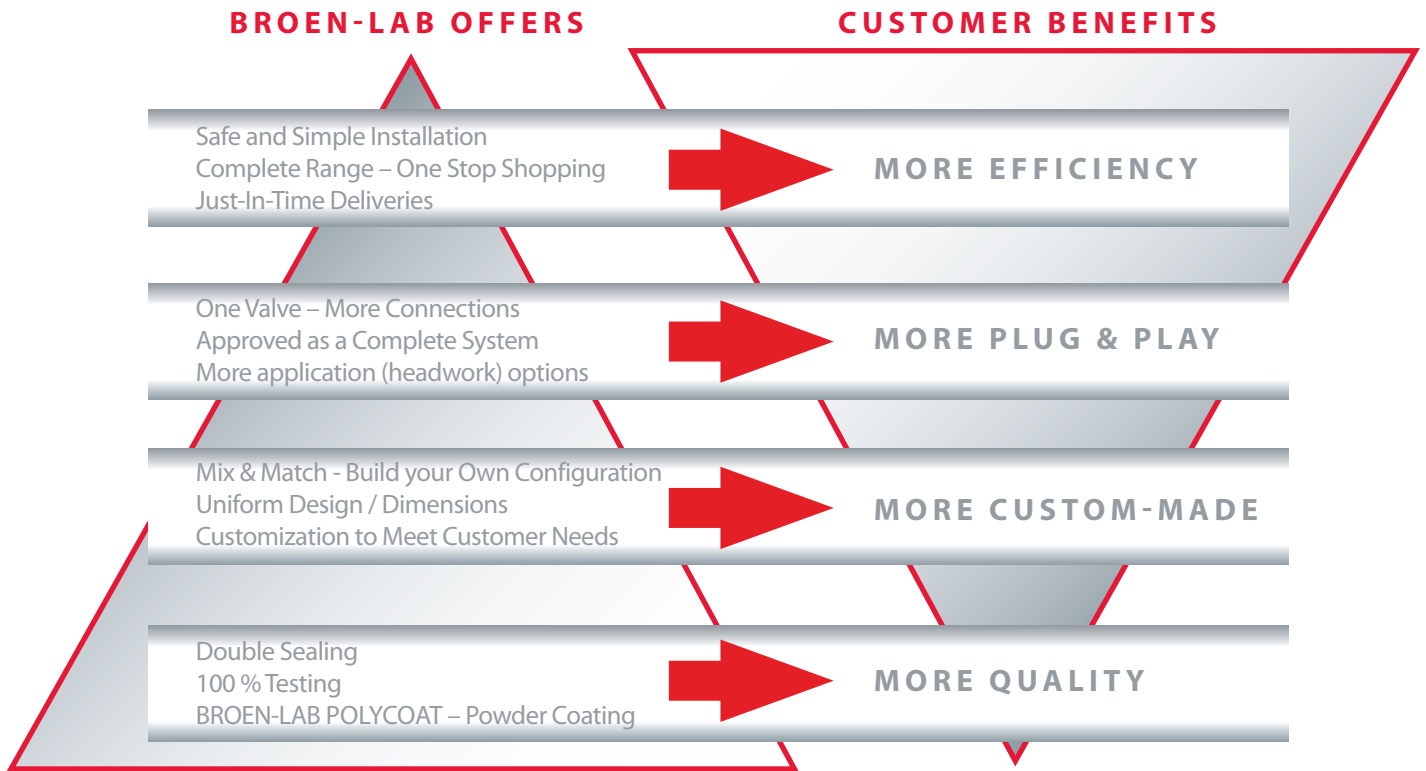

BROEN-LAB UniFlex™ fittings for non-burning 4.0 gases are designed for laboratory use and are adapted to Oxygen service.

The operation and the configuration of the fittings are highly adapted to the requirements of a modern laboratory. The fittings are surface treated with BROEN-LAB POLYCOAT powder coating, which is highly resistant to most chemicals, UV fading and heat (for more information please refer to “BROEN-LAB POLYCOAT” brochure).

All BROEN-LAB UniFlex™ fittings are delivered with a polypropylene handle with media indication according to EN13792. As an option it is possible to get fittings with disability-friendly handle for easier operation.

BROEN-LAB UniFlex™ fittings for non-burning 4.0 gases / Oxygen are delivered with a fixed metal nozzle (can be removed with Allen key if needed) or a quick release coupling (hexagon coded) for easy and immediate connection and safe disconnection.

THIS IS BROEN-LAB UNIFLEX™

BROEN-LAB UniFlex™ is a unique and patented connection, which allows customers to choose from various connection methods, such as hoses, Cu, PEX or Stainless Steel pipes, without changing the valve itself. It provides unique flexibility, not only for the installer, but also for the end-user. Due to the flexibility of the system, the quick installation and savings on fittings, this system offers lower TIC (Total Installed Costs).

WHAT IS NON-BURNING 4.0 GAS?

Non-burning 4.0 gases are typical industrial and technical gases that are 99,99% clean and should be used in applications where impurities must be avoided. Common media that require oil and grease-free fittings are Oxygen, Instrumental, Synthetic and Medical air as well as Helium and other oil-free gases for use with critical instrumentation.

BROEN-LAB UniFlex™ fittings for non-burning 4.0 gases are adapted to Oxygen service, meaning that the presence of mineral based oils and grease is minimized. Materials with media contact are Oxygen approved and ultrasonically cleaned. Assembled fittings are individually packed into sealed plastic bags.

WHAT IS OXYGEN?

Oxygen is the most abundant element on the earth's surface. In its most well-known form it constitutes 21% of the atmosphere, it is a tasteless, odorless and colorless gas essential to life.

Oxygen itself is not the fuel, but the oxidant and can ignite or support a fire if it comes into contact with flammable substances.

Oxygen is used in innumerable application in industries such as:

- chemicals
- pharmaceuticals
- healthcare
- laboratory and analysis
- food and beverage
- electronics, etc.



SYSTEM REQUIREMENTS

Due to the physical and chemical properties of Oxygen the following requirements are set up to an Oxygen system:

- valves and fittings that should be applied with Oxygen must be free of mineral based oil and grease
- materials that come into contact with Oxygen (metals, O-rings, gaskets, plastics, lubricants, etc.) must be Oxygen approved
- recommended working pressure for Oxygen must not be exceeded
- valves must be opened slowly in order to avoid possible ignition.

OUR HEADWORKS

BROEN-LAB UniFlex™ fittings for non-burning 4.0 gases can be delivered with 2 different types of headworks depending on the requirements set by applications with regards to regulation of media flow.

Needle headwork

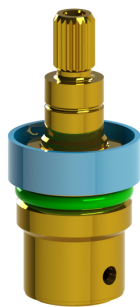

Micro flow headwork

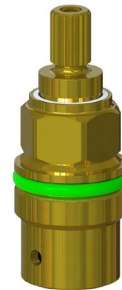

As standard all BROEN-LAB UniFlex™ fittings for non-burning 4.0 gases are delivered with a needle headwork that allows fine regulation of media flow and the valve is fully opened after 3 x 360° rotations of a handle.

In cases where media flow is close to zero and when a microscopic flow rate is required then it is an option to choose a micro flow headwork, which provides a very fine regulation of media flow.

For more information about BROEN-LAB headworks and technical details please refer to page 20 in this catalogue.

TURRET FITTINGS

With fixed nozzle

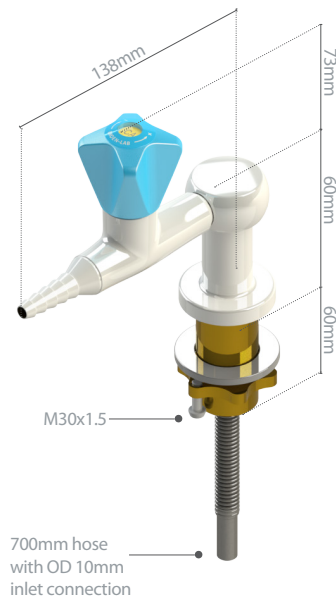

With quick release coupling

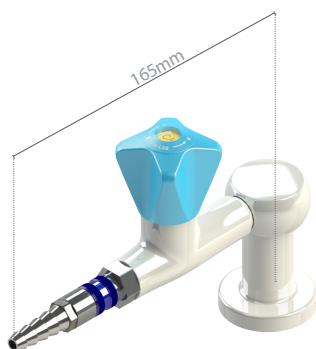

SPECIFICATIONS

Handle: Polypropylene with media indication according to EN13792

Hose nozzle: Metal, fixed (can be unscrewed with Allen key, thread: male G3/8)

Headwork: Needle

Opening/closing function: 3 x 360°

Max. working pressure:

16 bar / 232 psi

Allowable test pressure after installation:

1.5 x max working pressure without function of the valve

MATERIALS WITH MEDIA CONTACT

Materials with media contact are Oxygen approved and ultrasonically cleaned.

Metals: Brass

Plastics: PVDF, PTFE (hose)

Sealing: FKM

Lubricant: Perfluoropolyether based

ORDERING INFORMATION











For standard configuration please refer to the item numbers below.

Other options:

- different media
- removable hose nozzle with union nut
- disability-friendly handle (single valve only)
- micro flow headwork
- alternative hose inlet connection / without a hose
- other inlet options (type, length)

TURRET FITTINGS











Model: with fixed nozzle

Media	 1-valve	 2-valve 90°	 2-valve 180°	 4-valve
 Compressed air	2532 075 1021-52B	2532 063 1021-52B	2532 076 1021-52B	2532 091 1021-52B
 Oxygen	2532 075 1022-52B	2532 063 1022-52B	2532 076 1022-52B	2532 091 1022-52B
 Nitrogen	2532 075 1023-52B	2532 063 1023-52B	2532 076 1023-52B	2532 091 1023-52B
 Carbon dioxide	2532 075 1024-52B	2532 063 1024-52B	2532 076 1024-52B	2532 091 1024-52B
 Argon	2532 075 1025-52B	2532 063 1025-52B	2532 076 1025-52B	2532 091 1025-52B
 Helium	2532 075 1026-52B	2532 063 1026-52B	2532 076 1026-52B	2532 091 1026-52B
 Dinitrogen monoxide	2532 075 1027-52B	2532 063 1027-52B	2532 076 1027-52B	2532 091 1027-52B

Fittings are delivered with a 700mm PTFE hose with OD10mm inlet connector.

For other options please refer to page 18 or contact your local BROEN-LAB representative.

Model: with quick release coupling (hexagon coded)

Media	 1-valve	 2-valve 90°	 2-valve 180°	 4-valve
 Compressed air	2532 127 1021-52B	2532 128 1021-52B	2532 129 1021-52B	2532 130 1021-52B
 Oxygen	2532 127 1022-52B	2532 128 1022-52B	2532 129 1022-52B	2532 130 1022-52B
 Nitrogen	2532 127 1023-52B	2532 128 1023-52B	2532 129 1023-52B	2532 130 1023-52B
 Carbon dioxide	2532 127 1024-52B	2532 128 1024-52B	2532 129 1024-52B	2532 130 1024-52B
 Argon	2532 127 1025-52B	2532 128 1025-52B	2532 129 1025-52B	2532 130 1025-52B
 Helium	2532 127 1026-52B	2532 128 1026-52B	2532 129 1026-52B	2532 130 1026-52B
 Dinitrogen monoxide	2532 127 1027-52B	2532 128 1027-52B	2532 129 1027-52B	2532 130 1027-52B

Fittings are delivered with a 700mm PTFE hose with OD10mm inlet connector.

For other options please refer to page 18 or contact your local BROEN-LAB representative.

SUSPENDED FITTINGS WITH 90° VALVES

With fixed nozzle

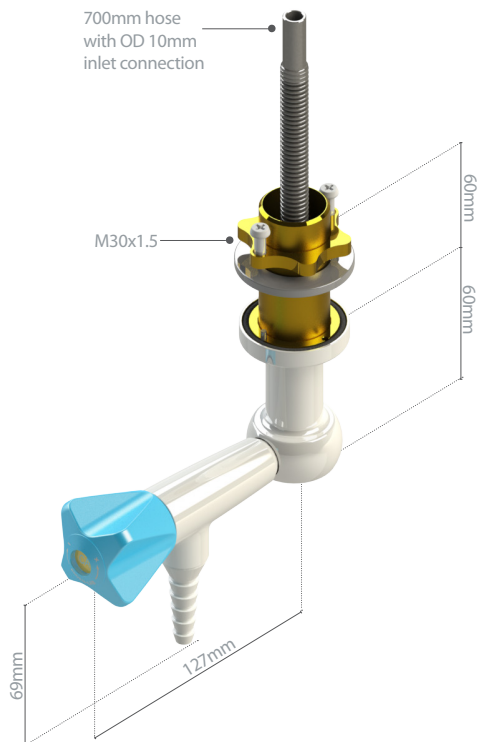

SPECIFICATIONS

Handle: Polypropylene with media indication according to EN13792

Hose nozzle: Metal, fixed (can be unscrewed with Allen key, thread: male G3/8)

Headwork: Needle

Opening/closing function: 3 x 360°

Max. working pressure:

16 bar / 232 psi

Allowable test pressure after installation:

1.5 x max working pressure without function of the valve

MATERIALS WITH MEDIA CONTACT

Materials with media contact are Oxygen approved and ultrasonically cleaned.

Metals: Brass

Plastics: PVDF, PTFE (hose)

Sealing: FKM

Lubricant: Perfluoropolyether based

ORDERING INFORMATION

For standard configuration please refer to the item numbers below.

Other options:

- different media
- removable hose nozzle with union nut
- micro flow headwork
- alternative hose inlet connection / without a hose
- other inlet options (type, length)

With quick release coupling

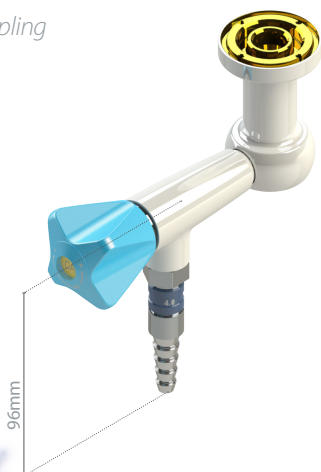

BROEN-LAB UNIFLEX™ FITTINGS FOR NON-BURNING 4.0 GASES / OXYGEN



For further information and mounting instructions please refer to www.BROEN-LAB.com or contact your local BROEN-LAB representative.

SUSPENDED FITTINGS WITH 90° VALVES

Model: with fixed nozzle



Media	1-valve	2-valve 90°	2-valve 180°	4-valve
Compressed air	2530 072 1021-52B	2530 131 1021-52B	2530 073 1021-52B	2530 253 1021-52B
Oxygen	2530 072 1022-52B	2530 131 1022-52B	2530 073 1022-52B	2530 253 1022-52B
Nitrogen	2530 072 1023-52B	2530 131 1023-52B	2530 073 1023-52B	2530 253 1023-52B
Carbon dioxide	2530 072 1024-52B	2530 131 1024-52B	2530 073 1024-52B	2530 253 1024-52B
Argon	2530 072 1025-52B	2530 131 1025-52B	2530 073 1025-52B	2530 253 1025-52B
Helium	2530 072 1026-52B	2530 131 1026-52B	2530 073 1026-52B	2530 253 1026-52B
Dinitrogen monoxide	2530 072 1027-52B	2530 131 1027-52B	2530 073 1027-52B	2530 253 1027-52B

Fittings are delivered with a 700mm PTFE hose with OD10mm inlet connector.

For other options please refer to page 18 or contact your local BROEN-LAB representative.

Model: with quick release coupling (hexagon coded)

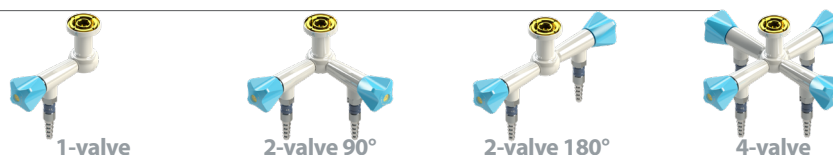

Media	1-valve	2-valve 90°	2-valve 180°	4-valve
Compressed air	2530 238 1021-52B	2530 239 1021-52B	2530 240 1021-52B	2530 241 1021-52B
Oxygen	2530 238 1022-52B	2530 239 1022-52B	2530 240 1022-52B	2530 241 1022-52B
Nitrogen	2530 238 1023-52B	2530 239 1023-52B	2530 240 1023-52B	2530 241 1023-52B
Carbon dioxide	2530 238 1024-52B	2530 239 1024-52B	2530 240 1024-52B	2530 241 1024-52B
Argon	2530 238 1025-52B	2530 239 1025-52B	2530 240 1025-52B	2530 241 1025-52B
Helium	2530 238 1026-52B	2530 239 1026-52B	2530 240 1026-52B	2530 241 1026-52B
Dinitrogen monoxide	2530 238 1027-52B	2530 239 1027-52B	2530 240 1027-52B	2530 241 1027-52B

Fittings are delivered with a 700mm PTFE hose with OD10mm inlet connector.

For other options please refer to page 18 or contact your local BROEN-LAB representative.

SUSPENDED FITTINGS WITH 45° VALVES

With fixed nozzle

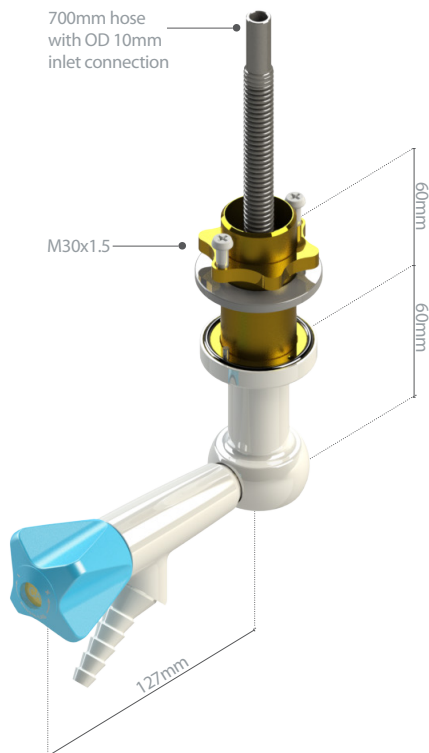

SPECIFICATIONS

Handle: Polypropylene with media indication according to EN13792

Hose nozzle: Metal, fixed (can be unscrewed with Allen key, thread: male G3/8)

Headwork: Needle

Opening/closing function: 3 x 360°

Max. working pressure:

16 bar / 232 psi

Allowable test pressure after installation:

1.5 x max working pressure without function of the valve

MATERIALS WITH MEDIA CONTACT

Materials with media contact are Oxygen approved and ultrasonically cleaned.

Metals: Brass

Plastics: PVDF, PTFE (hose)

Sealing: FKM

Lubricant: Perfluoropolyether based

ORDERING INFORMATION

For standard configuration please refer to the item numbers below.

Other options:

- different media
- removable hose nozzle with union nut
- micro flow headwork
- alternative hose inlet connection / without a hose
- other inlet options (type, length)

With quick release coupling



BROEN-LAB UNIFLEX™ FITTINGS FOR NON-BURNING 4.0 GASES / OXYGEN



For further information and mounting instructions please refer to www.BROEN-LAB.com or contact your local BROEN-LAB representative.

SUSPENDED FITTINGS WITH 45° VALVES

Model: with fixed nozzle



Media	1-valve	2-valve 90°	2-valve 180°	4-valve
Compressed air	2530 242 1021-52B	2530 254 1021-52B	2530 243 1021-52B	2530 244 1021-52B
Oxygen	2530 242 1022-52B	2530 254 1022-52B	2530 243 1022-52B	2530 244 1022-52B
Nitrogen	2530 242 1023-52B	2530 254 1023-52B	2530 243 1023-52B	2530 244 1023-52B
Carbon dioxide	2530 242 1024-52B	2530 254 1024-52B	2530 243 1024-52B	2530 244 1024-52B
Argon	2530 242 1025-52B	2530 254 1025-52B	2530 243 1025-52B	2530 244 1025-52B
Helium	2530 242 1026-52B	2530 254 1026-52B	2530 243 1026-52B	2530 244 1026-52B
Dinitrogen monoxide	2530 242 1027-52B	2530 254 1027-52B	2530 243 1027-52B	2530 244 1027-52B

Fittings are delivered with a 700mm PTFE hose with OD10mm inlet connector.

For other options please refer to page 18 or contact your local BROEN-LAB representative.

Model: with quick release coupling

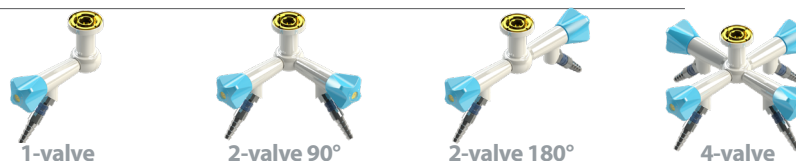

Media	1-valve	2-valve 90°	2-valve 180°	4-valve
Compressed air	2530 245 1021-52B	2530 246 1021-52B	2530 247 1021-52B	2530 248 1021-52B
Oxygen	2530 245 1022-52B	2530 246 1022-52B	2530 247 1022-52B	2530 248 1022-52B
Nitrogen	2530 245 1023-52B	2530 246 1023-52B	2530 247 1023-52B	2530 248 1023-52B
Carbon dioxide	2530 245 1024-52B	2530 246 1024-52B	2530 247 1024-52B	2530 248 1024-52B
Argon	2530 245 1025-52B	2530 246 1025-52B	2530 247 1025-52B	2530 248 1025-52B
Helium	2530 245 1026-52B	2530 246 1026-52B	2530 247 1026-52B	2530 248 1026-52B
Dinitrogen monoxide	2530 245 1027-52B	2530 246 1027-52B	2530 247 1027-52B	2530 248 1027-52B

Fittings are delivered with a 700mm PTFE hose with OD10mm inlet connector.

For other options please refer to page 18 or contact your local BROEN-LAB representative.

DOUBLE WALL FITTINGS WITH 90° VALVES

With fixed nozzle

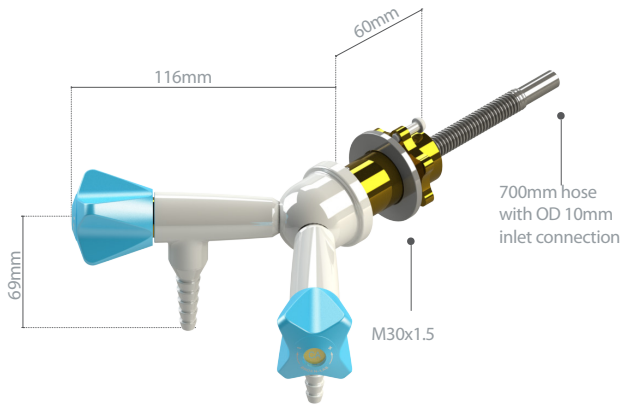

With quick release coupling

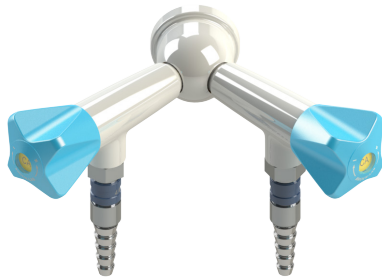

SPECIFICATIONS

Handle: Polypropylene with media indication according to EN13792

Hose nozzle: Metal, fixed (can be unscrewed with Allen key, thread: male G3/8)

Headwork: Needle

Opening/closing function: 3 x 360°

Max. working pressure:

16 bar / 232 psi

Allowable test pressure after installation:

1.5 x max working pressure without function of the valve

MATERIALS WITH MEDIA CONTACT

Materials with media contact are Oxygen approved and ultrasonically cleaned.

Metals: Brass

Plastics: PVDF, PTFE (hose)

Sealing: FKM

Lubricant: Perfluoropolyether based

ORDERING INFORMATION

For standard configuration please refer to the item numbers below.

Other options:

- different media
- removable hose nozzle with union nut
- disability-friendly handle
- micro flow headwork
- alternative hose inlet connection / without a hose
- other inlet options (type, length)

Models

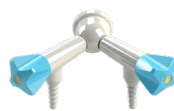

with fixed nozzle

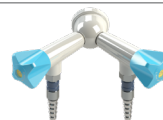

with quick release coupling (hexagon coded)

Media

Compressed air	2530 249 1021-52B	2530 250 1021-52B
Oxygen	2530 249 1022-52B	2530 250 1022-52B
Nitrogen	2530 249 1023-52B	2530 250 1023-52B
Carbon dioxide	2530 249 1024-52B	2530 250 1024-52B
Argon	2530 249 1025-52B	2530 250 1025-52B
Helium	2530 249 1026-52B	2530 250 1026-52B
Dinitrogen monoxide	2530 249 1027-52B	2530 250 1027-52B

Fittings are delivered with a 700mm PTFE hose with OD10mm inlet connection.

For other options please refer to page 18 or contact your local BROEN-LAB representative.

For further information and mounting instructions please refer to www.BROEN-LAB.com or contact your local BROEN-LAB representative.

DOUBLE WALL FITTINGS WITH STRAIGHT VALVES

With fixed nozzle

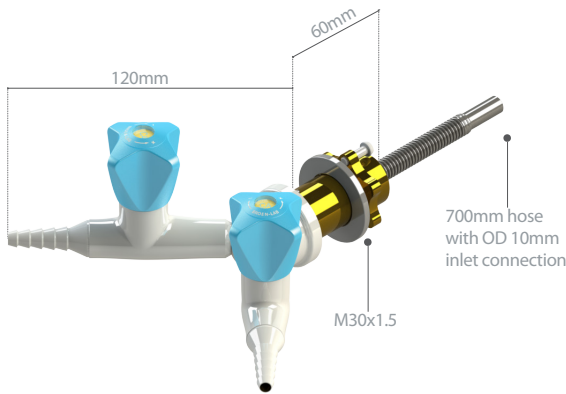

With quick release coupling

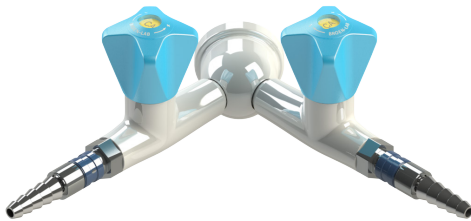

SPECIFICATIONS

Handle: Polypropylene with media indication according to EN13792

Hose nozzle: Metal, fixed (can be unscrewed with Allen key, thread: male G3/8)

Headwork: Needle

Opening/closing function: 3 x 360°

Max. working pressure:

16 bar / 232 psi

Allowable test pressure after installation:

1.5 x max working pressure without function of the valve

MATERIALS WITH MEDIA CONTACT

Materials with media contact are Oxygen approved and ultrasonically cleaned.

Metals: Brass

Plastics: PVDF, PTFE (hose)

Sealing: FKM

Lubricant: Perfluoropolyether based

ORDERING INFORMATION

For standard configuration please refer to the item numbers below.

Other options:

- different media
- removable hose nozzle with union nut
- micro flow headwork
- alternative hose inlet connection / without a hose
- other inlet options (type, length)

Models

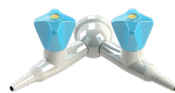

with fixed nozzle



with quick release coupling

Media	with fixed nozzle	with quick release coupling
Compressed air	2532 064 1021-52B	2532 132 1021-52B
Oxygen	2532 064 1022-52B	2532 132 1021-52B
Nitrogen	2532 064 1023-52B	2532 132 1023-52B
Carbon dioxide	2532 064 1024-52B	2532 132 1024-52B
Argon	2532 064 1025-52B	2532 132 1025-52B
Helium	2532 064 1026-52B	2532 132 1026-52B
Dinitrogen monoxide	2532 064 1027-52B	2532 132 1027-52B

Fittings are delivered with a 700mm PTFE hose with OD10mm inlet connection.

For other options please refer to page 18 or contact your local BROEN-LAB representative.

For further information and mounting instructions please refer to www.BROEN-LAB.com or contact your local BROEN-LAB representative.

WALL MOUNTED FITTINGS WITH 90° VALVES FOR EXPOSED PIPING

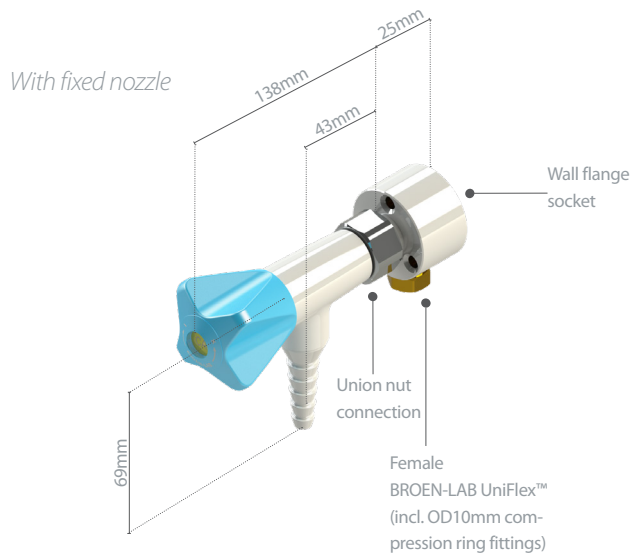

With quick release coupling

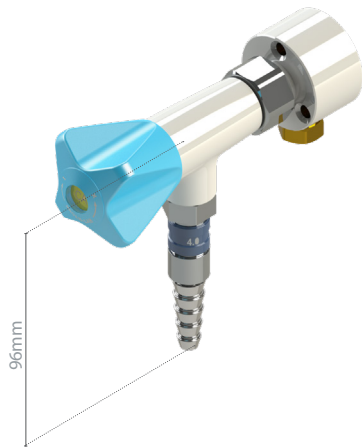

SPECIFICATIONS

Handle: Polypropylene with media indication according to EN13792

Hose nozzle: Metal, fixed (can be unscrewed with Allen key, thread: male G3/8)

Headwork: Needle

Opening/closing function: 3 x 360°

Max. working pressure:

16 bar / 232 psi

Allowable test pressure after installation:

1.5 x max working pressure without function of the valve

MATERIALS WITH MEDIA CONTACT

Materials with media contact are Oxygen approved and ultrasonically cleaned.

Metals: Brass

Plastics: PVDF, PTFE (hose)

Sealing: FKM

Lubricant: Perfluoropolyether based

ORDERING INFORMATION

For standard configuration please refer to the item numbers below.

Other options:

- different media
- removable hose nozzle with union nut
- disability-friendly handle
- micro flow headwork
- alternative hose inlet connection / without a hose
- other inlet options (type, length)
- model with straight valve

Models

Media	with fixed nozzle	with quick release coupling (hexagon coded)
Compressed air	2530 251 1021-T	2530 252 1021-T
Oxygen	2530 251 1022-T	2530 252 1022-T
Nitrogen	2530 251 1023-T	2530 252 1023-T
Carbon dioxide	2530 251 1024-T	2530 252 1024-T
Argon	2530 251 1025-T	2530 252 1025-T
Helium	2530 251 1026-T	2530 252 1026-T
Dinitrogen monoxide	2530 251 1027-T	2530 252 1027-T

Delivered with wall flange socket and compression ring fitting for OD10mm Cu-pipe.

For other options please refer to page 15 or contact BROEN-LAB representative.

SUSPENDED OR WALL MOUNTED FITTINGS

SPECIFICATIONS

Handle: Polypropylene with media indication according to EN13792

Hose nozzle: Metal, fixed (can be unscrewed with Allen key, thread: male G3/8)

Headwork: Needle

Opening/closing function: 3 x 360°

Max. working pressure:

16 bar / 232 psi

Allowable test pressure after installation:

1.5 x max working pressure without function of the valve

MATERIALS WITH MEDIA CONTACT

Materials with media contact are Oxygen approved and ultrasonically cleaned.

Metals: Brass

Plastics: PVDF

Sealing: FKM

Lubricant: Perfluoropolyether based

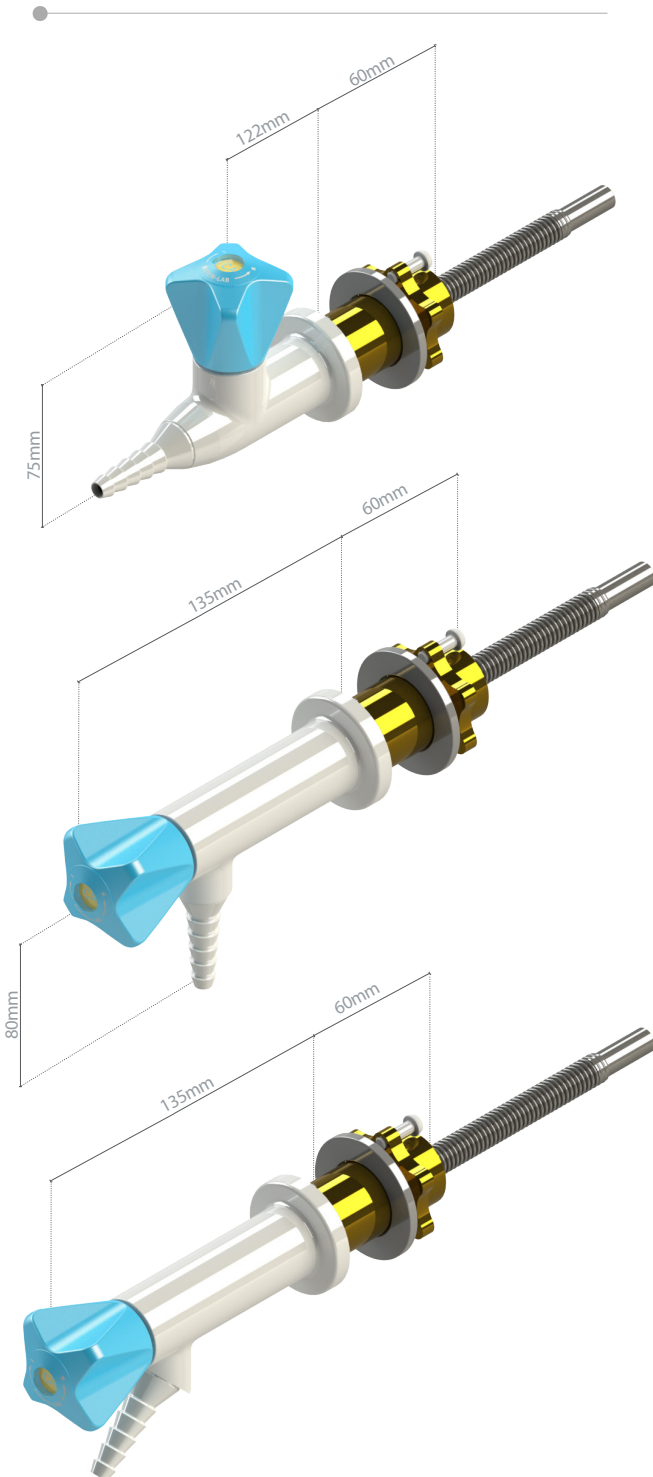

2532 168 10xx-52B - Non-burning 4.0 gases / Oxygen (with fixed nozzle)

2532 170 10xx-52B - Non-burning 4.0 gases / Oxygen (with hexagon coded quick release coupling)

For media XX please refer to page 19.

Fittings are delivered with a 700mm PTFE hose with OD10mm inlet connector.

If you need another type of inlet connection please contact your sales representative.

2530 331 10xx-52B - Non-burning 4.0 gases / Oxygen, 90° valve (with fixed nozzle)

2530 332 10xx-52B - Non-burning 4.0 gases / Oxygen, 90° valve (with hexagon coded quick release coupling)

For media XX please refer to page 19.

Fittings are delivered with a 700mm PTFE hose with OD10mm inlet connector.

If you need another type of inlet connection please contact your sales representative.

2530 349 10xx-52B - Non-burning 4.0 gases / Oxygen, 45° Valve (with fixed nozzle)

2530 350 10xx-52B - Non-burning 4.0 gases / Oxygen, 90° valve (with hexagon coded quick release coupling)

For media XX please refer to page 19.

Fittings are delivered with a 700mm PTFE hose with OD10mm inlet connector.

If you need another type of inlet connection please contact your sales representative.

For further information and mounting instructions please refer to www.BROEN-LAB.com or contact your local BROEN-LAB representative.

93Q - BROEN-LAB UNIFLEX™ FLEXIBLE STAINLESS STEEL PIPES FOR OXYGEN AND HIGH PURITY GASES UP TO 5.0

BROEN-LAB UNIFLEX™ FITTINGS FOR NON-BURNING 4.0 GASES / OXYGEN

INLET CONNECTIONS 93 Q XX XX XXXX

OD10mm connection for compression fittings (Code 10)



OD12mm connection for compression fittings (Code 12)



OD15mm connection for compression fittings (Code 15)



OD3/8" connection for compression fittings (Code 09)



Straight BROEN-LAB UniFlex™ connection with FKM O-ring (Code 20)



3/8" NPT Fixed male connection (Code 34)



1/4" NPT fixed male connection (Code 70)



Female 3/8" union nut connection (Code 41)



Female 1/2" A union nut connection (Code 40)



90° BROEN-LAB Uniflex connection with FKM O-ring (Code 30)

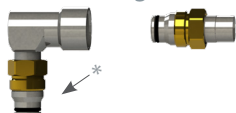

OUTLET CONNECTIONS 93 Q XX XX XXXX

Straight BROEN-LAB UniFlex™ connection with FKM O-ring (Code 20)

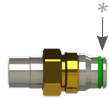

90° BROEN-LAB Uniflex connection with FKM O-ring (Code 30)

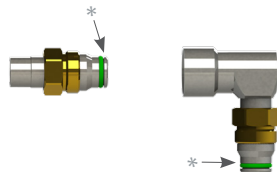

*All O-rings are lubricated with perfluoropolyether based lubricant

HOSE 93 Q XX XX XXXX



HOSE LENGTHS

Definition of length (L)

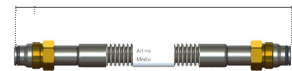

**Standard lengths of hoses (L):

- 0500 = 500mm
- 0700 = 700mm
- 1000 = 1000mm
- 1200 = 1200mm
- 1500 = 1500mm
- 2000 = 2000mm
- 2500 = 2500mm
- 3000 = 3000mm

Length tolerance of hoses:
 L ≤ 400mm (-0, +10mm)
 L = 401mm to 1000mm (-0, +20mm)
 L > 1000mm (-0, +30mm)

SPECIFICATIONS

- Inner hose material:** Stainless Steel 1.4404 similar to AISI 316L
- Braiding:** None
- Materials with media contact:** Stainless Steel 1.4404, FKM (Viton), Perfluoropolyether based lubricant
- Inside diameter:** 8.5mm
- Outside diameter:** 12mm
- Max. working pressure:** 21bar
- Max. working temperature:** 50°C
- Bending radius (inner):**
 - ≥ 15 mm (static)
 - ≥ 130 mm (dynamic)
- Min. length with connections:** 500mm
- Max. movements (Bending radius 130mm):** 10.000**
- Leakage rate:** 1×10^{-7} mbar l/s (He)

EXAMPLE OF HOSE CONFIGURATION

1200mm hose with OD 12mm inlet connection and straight UniFlex™ outlet connection



* Other lengths are available on request
 ** In accordance with ISO 10380

HEADWORKS

NEEDLE HEADWORK

SPECIFICATIONS

BROEN-LAB UniFlex™ fittings for non-burning 4.0 gases / Oxygen are as a standard delivered with needle headwork for fine regulation of media flow.

Opening/closing function: 3 x 360° turn

Media: Non-burning 4.0 (99.99% clean) gases / Oxygen

Max. working pressure: 16 bar / 232 psi

Allowable test pressure after installation:

1.5 x max. working pressure without function of the valve

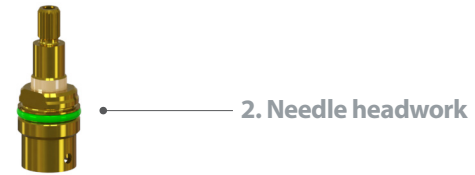

MATERIALS WITH MEDIA CONTACT

Metals: Brass

Plastics: PVDF

Sealing: FKM

Lubricant: Perfluoropolyether based

ORDERING INFORMATION

1. Blue plastic ring

No. 0255035-6308

2. Needle headwork

Not available as a spare part (for safety reasons)

FLOW CHART

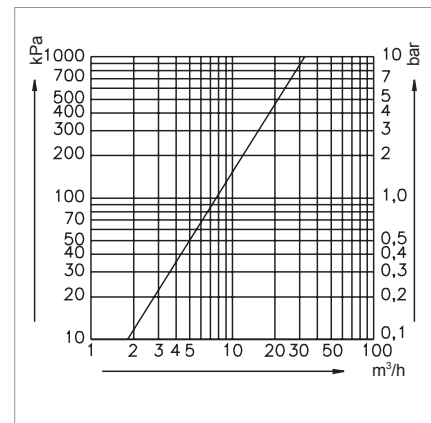

MICRO FLOW HEADWORK

SPECIFICATIONS

BROEN-LAB Micro flow headwork ensures very fine regulation of media where flow of gas is close to zero and microscopic flow rates are required.

Opening/closing function: 7.5 x 360° turn

Media: Non-burning 4.0 (99.99% clean) gases / Oxygen

Max. working pressure: 16 bar / 232 psi

Test pressure: 1.5 x working pressure

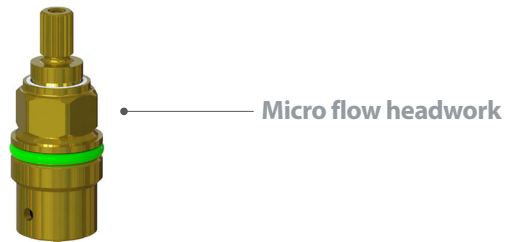

MATERIALS WITH MEDIA CONTACT

Metals: Brass

Plastics: PVDF

Sealing: FKM

Lubricant: Perfluoropolyether based

ORDERING INFORMATION

Not available as a spare part (for safety reasons).

FLOW CHART

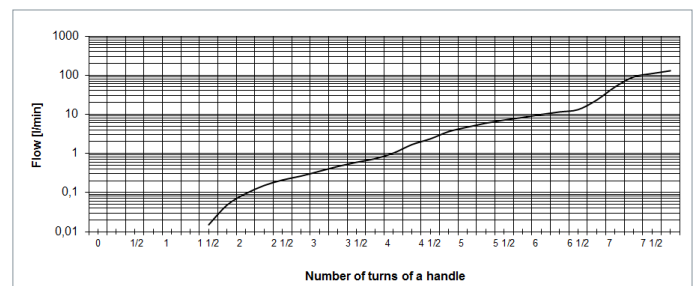

ACCESSORIES / SPARE PARTS

BROEN-LAB UNIFLEX™ FITTINGS FOR NON-BURNING 4.0 GASES / OXYGEN

Illustration	Description	BROEN-LAB item No.	
	Adaptor for removable metal nozzle	2539 043 1022	
	Removable metal nozzle	2539 008 1022	
	Fixed metal nozzle	2539 042 1022	
	Quick release coupling (hexagon coded)	19 633 00	
	Mounting set for G1/2 connection Mounting set for M30x1.5 connection	19 141 000 19 190 000	
	Inlet with 1/2" ISO 7/1-R thread and female BROEN-LAB UniFlex™ connection (incl. O-ring)	L=30mm L=60mm L=90mm	15 504 33R 15 504 12R 15 504 46R
	Threaded inlet pipe M30x1,5	L=30mm L=60mm L=90mm	19 190 03 19 190 02 19 190 04
	Wall flange socket (for exposed piping)		02 101 300G
	Wall flange socket (for built-in installation)		02 101 310
	Cover flange for 02 101 310		1492304G
	Polypropylene handle with media indication according to EN 13792		191501401021 (CA) 191501401022 (O ₂) 191501401023 (N ₂) 191501401024 (CO ₂) 191501401025 (Ar) 191501401026 (He) 191501401027 (N ₂ O)

ORDERING INFORMATION

BROEN-LAB UNIFLEX™ FITTINGS

Generally, item number for BROEN-LAB UniFlex fittings has the following structure:

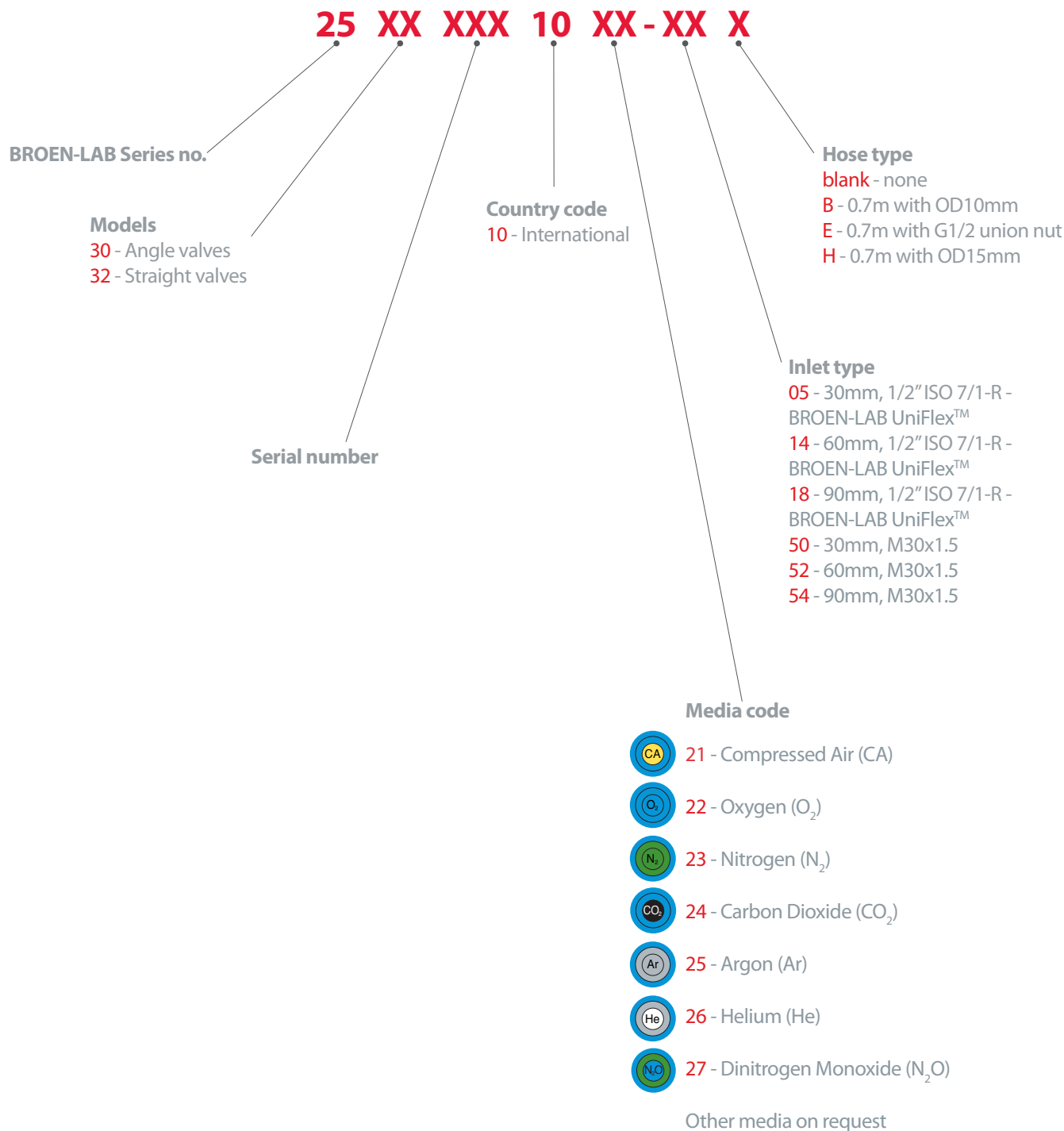

BROEN-LAB UNIFLEX™ FITTINGS FOR NON-BURNING 4.0 GASES / OXYGEN

For installation with Cu- and Stainless Steel BROEN-LAB offers a wide range of connection fittings and adapters for pipes of different dimensions. Please request document No. 99G0004 for a complete range of BROEN-LAB UniFlex™ compression ring fittings.

BROEN-LAB develops, manufactures and sells Laboratory Fittings, Emergency Shower Systems and Eye Wash Systems into a broad spectrum of laboratories and industrial locations; sectors include Pharmaceutical, Food&Beverage and Academia. Our expertise and product quality ensure optimal solutions compliant to all relevant international norms setting new standards in risk mitigation in modern research and development facilities.

BROEN-LAB offer solutions that ensure the functionality, compliance, hygiene, durability and safety are of the highest priority. For over 50 years our products have been integrated into a wide variety of workplaces, laboratories, hospitals and industrial locations, with features that are assessed and designed to be flexible, durable and compliant offering a broad range of options tailored to each location. This inherent design integrity provides confidence in the solution adopted wherever in the world these are applied.

BROEN-LAB is a collaboration partner in the design and layout of your next laboratory and it's integrated safety solutions.

HEAD OFFICE

BROEN-LAB A/S

Drejervaenget 2 • DK-5610 Assens
Denmark

Tel.: +45 6376 6376 • Fax +45 6471 2476

E-mail: lab@broen.com



BROEN-LAB A/S ISO 9001 certification

In September 1991 BROEN-LAB A/S was certified according to ISO 9001 as one of the first Danish companies. The certification was carried out by Bureau Veritas, Denmark, for our Danish site in Assens. The quality management system of BROEN-LAB A/S now complies with detailed specifications laid down by the internationally acknowledged EN ISO 9001:2015. This certification will further contribute to reputation for quality and reliability of BROEN-LAB A/S.

INTERNATIONAL OFFICES

BROEN-LAB Ltd

Tel. +44 121 522 4515

E-mail: lab@broen-lab.com

BROEN-LAB Singapore Pte. Ltd.

25 International Business Park #04-60A German Centre
Singapore 609916

Tel. +65 6298 0662 • Fax +65 6298 0468

E-mail: lab@broen-lab.com

BROEN-LAB GmbH

Tel.: +45 6376 6376 • Fax +45 6471 2476

E-mail: lab@broen-lab.com

BROEN-LAB Sverige AB

Tel.: +45 6376 6376 • Fax +45 6471 2476

E-mail: lab@broen-lab.com

BROEN-LAB Inc.

15 Constitution Drive Suite 122
Bedford • NH 03110 • USA

Tel.: +1 603 310 5089

E-mail: lab@broen-lab.com

www.BROEN-LAB.com

BROEN-LAB